

HYT

OWNER'S MANUAL

TC-580

www.hytera.cn

Hytera **HYT**

is the trademark of Hytera Communications Corp., Ltd.
© 2010 Hytera Corp., Ltd. All Rights Reserved.

Address: HYT Tower, Hi-Tech Industrial Park North, Beihuan
RD., Nanshan District, Shenzhen, China
Post: 518057
<http://www.hytera.cn>



8110058000120

L06774 X05031



Preface

Thank you for purchasing Hytera TC-580 portable radio. It incorporates ergonomic design, and practical features such as front panel programming and DTMF Encode & Decode. You can conveniently customize radio settings and make calls.

To derive optimum performance from your radio, please read the Safety Information Booklet and Owner's Manual carefully before use.

Icon Information

The following icons are available through this manual:



Caution: indicates situations that could cause damage to your radio.



Note: indicates tips that can help you make better use of your radio.

Term Explanation

The following terms will appear through this manual:

■ Key Operation

Short press: to press a key and release it quickly.

Long press: to press and hold down a key for above 1.5 seconds.

Hold down: to press a key and remain holding it down.

■ User Mode

Refers to the mode entered after you turn on the radio directly.

■ Manual Program Mode

Refers to the mode entered after you turn on the radio with both **PTT** and **SK2** held down for 1.5 seconds.

■ Zone

Zone is a group of channels, dedicated for you to organize channels.

■ Zone All

Includes all available channels.

■ DTMF

Dual-tone multi-frequency (DTMF) signaling is used for making selective calls, calling party identification, call alert and etc.

■ CTCSS/CDCSS

The signaling can help you prevent unwanted conversations at the same frequency.

■ PTT ID

PTT ID, namely radio identity, allows a radio with display and the control center to identify the calling party.

Copyright Information

Hytera and CRS are registered trademarks of Hytera in PRC and other countries and/or areas. Hytera retains the ownership of its trademarks and product names. All other trademarks and/or product names that may be used in this manual are properties of their respective owners.

The Hytera product described in this manual may include Hytera computer programs stored in memory or other media. Laws in the PRC and/or other countries or areas preserve for Hytera exclusive rights for Hytera computer programs. The purchase of this product shall not be deemed to grant, either directly or by implication, any rights to the purchaser with respect to Hytera computer programs. Any Hytera computer programs may not be copied, modified, distributed, decompiled, or reverse-engineered in any manner without the prior written consent of Hytera.

Disclaimer

Hytera endeavors to achieve the accuracy and completeness of this manual, but no warranty of accuracy or reliability is given. All the specifications and designs are subject to change without prior notice due to continuous technology development. No part of this manual may be copied, modified, translated, or distributed in any manner without the express written permission of Hytera.

If you have any suggestions or would like to learn more details, please visit us at: <http://www.hytera.cn>.

RF Energy Exposure Compliance

Your radio is designed and tested to comply with a number of national and international standards and guidelines (listed below) regarding human exposure to radio frequency electromagnetic energy. This radio complies with the IEEE and ICNIRP exposure limits for occupational/controlled RF exposure environment at operating duty factors of up to 50% transmitting and is authorized by the FCC for occupational use only. In terms of measuring RF energy for compliance with the FCC exposure guidelines, your radio radiates measurable RF energy only while it is transmitting (during talking), not when it is receiving (listening) or in standby mode.

Your radio complies with the following of RF energy exposure standards and guidelines

- United States Federal Communications Commission, Code of Federal Regulations; 47CFR part 2 sub-part J
- American National Standards Institute (ANSI)/ Institute of Electrical and Electronic Engineers (IEEE) C95. 1-1992
- Institute of Electrical and Electronic Engineers (IEEE) C95. 1-1999 Edition
- International Commission on Non-Ionizing Radiation Protection (ICNIRP) 1998

Operational Instructions and Training Guidelines

To ensure optimal performance and compliance with the occupational/controlled environment RF energy exposure limits in the above standards and guidelines, users should transmit no more than 50% of the time and always adhere to the following procedures:

Transmit and Receive

To transmit (talk), push the Push-To-Talk (PTT) key; to receive, release the PTT key.

FCC Licensing Information

Part 15 Compliance

This equipment has been tested and found to comply with the limits for a Class B digital device, pursuant to part 15 of the FCC Rules. These limits are designed to provide reasonable protection against harmful interference in a residential installation. This equipment generates, uses and can radiate radio frequency energy and, if not installed and used in accordance with the instructions, may cause harmful interference to radio communications. However, there is no guarantee that interference will not occur in a particular installation. If this equipment does cause harmful interference to radio or television reception, which can be determined by turning the equipment off and on, the user is encouraged to try to correct the interference by one or more of the following measures:

- Reorient or relocate the receiving antenna.
- Increase the separation between the equipment and receiver.

- Connect the equipment into an outlet on a circuit different from that to which the receiver is connected.
- Consult the dealer or an experienced radio/TV technician for help.

FCC Licensing Requirements

A license from Federal Communications Commission is required prior to use. Your dealer will program each radio with your authorized frequencies, signaling codes, etc., and will be there to meet your communications needs as your system expands. Contact your dealer for more information.

Contents

Checking Items in the Package -----	3	Adjusting Power Level-----	14
Radio Overview -----	4	Transmitting/Receiving a Call -----	14
Radio Controls -----	4	Locking/Unlocking the Keypad-----	15
Programmable Keys-----	5	Menu Navigation-----	16
Before Use-----	7	Call List-----	16
Charging the Battery-----	7	Zone -----	16
Assembly and Disassembly-----	8	Settings -----	16
Status Indications-----	10	Scan -----	19
LCD Icons -----	10	Keypad Mode-----	19
LED Indicator -----	11	Functions and Operations -----	20
Basic Operations-----	12	Time-out Timer (TOT) -----	20
Turning the Radio On/Off-----	12	Channel Scan -----	20
Entering Power-on Password -----	12	Emergency -----	22
Adjusting the Volume -----	12	Quick Call-----	22
Selecting a Zone-----	12	Home Channel -----	23
Selecting a Channel -----	13	Display Mode Switch -----	23
Inputting a Frequency -----	13	Keypad Mode Switch -----	24

Contents

Talk Around-----	24
Monitor -----	24
Squelch Off-----	25
Compandor-----	25
Scrambler-----	26
VOX-----	26
Whisper -----	27
Reverse Display -----	27
Signaling Introduction-----	28
CTCSS/CDCSS-----	28
Dual Tone Multiple Frequency (DTMF) -----	28
Manual Program -----	30
CH Set-----	31
Zone Set-----	34
Troubleshooting -----	36
Care and Cleaning -----	38
Optional Accessories -----	39
Appendix: Input Method-----	41

Checking Items in the Package

Please unpack carefully and check that all items listed below are received. If any item is missing or damaged, please contact your dealer.

① Radio Unit



② Battery

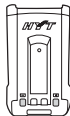

③ Rapid-rate Charger
(for Li-Ion battery)



④ Power Adapter (different P/N for
different countries and areas)



⑤ Antenna



⑥ Belt Clip



⑦ Strap



⑧ Owner's Manual / Safety Information
Booklet

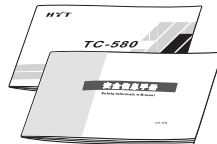

Note:

- The above pictures are for reference only. Actual products may vary slightly.
- The antenna may vary with different frequency bands. And the frequency band is marked on the label of antenna; if not, please refer to the label on the radio for frequency band information.

Radio Overview

Radio Controls

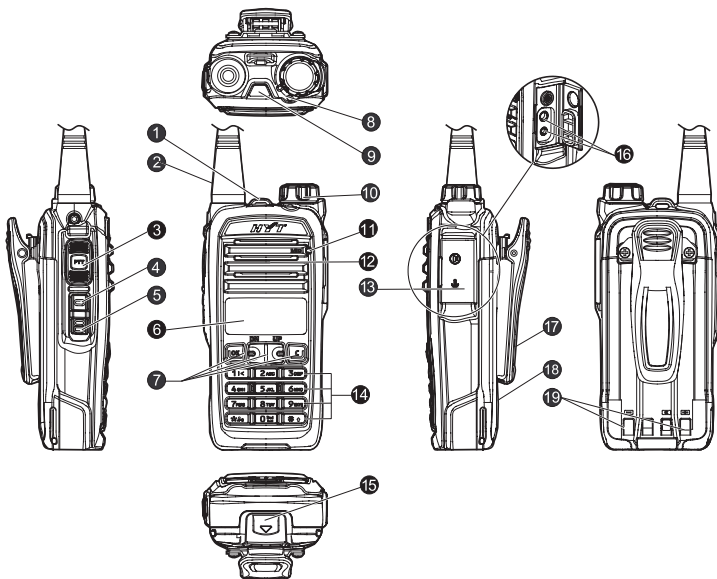

No.	Part Name
1	Strap Hole
2	Antenna
3	PTT Key
4	SK1 (programmable)
5	SK2 (programmable)
6	LCD Display
7	Function Keypad
8	LED Indicator
9	TK (programmable)
10	Radio On-Off/Volume Control Knob
11	Microphone
12	Speaker
13	Accessory Jack Cover
14	Numeric Keypad
15	Battery Latch
16	Accessory Jack
17	Belt Clip
18	Battery
19	Charging Piece

Radio Overview

Programmable Keys

For enhanced convenience, you may request your dealer to program the keys **SK1**, **SK2**, and **TK** as shortcuts to the functions listed below:

No.	Shortcut Keys	Description
1	Adjust Power Level	To adjust power level through one button press.
2	Call 1	To quickly make a call to a pre-defined user.
3	Call 2	
4	Call 3	
5	Call 4	
6	Call 5	
7	Companion	For clear voice in noisy environments.
8	Display Mode Switch	To switch display of channel information among channel No., channel alias and channel frequency.
9	Emergency	To summon help in emergent situations.

10	Home Channel	To quickly switch to the Home channel.
11	Keypad Mode	To quickly switch keypad entry among frequency, channel, DTMF, or to disable it.
12	Monitor	To adjust the condition for incoming signal match.
13	Monitor Momentary	
14	Squelch Off	To always unmute speaker no matter whether carrier is present or not.
15	Squelch Off Momentary	
16	Scan	To receive signals on other channels.
17	Scrambler	To encrypt voice and thus protect your conversations from eavesdropping.
18	VOX	The radio can automatically begin to transmit when you speak.

Radio Overview

19	Whisper	The feature allows you to speak quietly into the radio and still be heard clearly.
20	Reverse Display	To invert display contents 180 degrees.
21	Talk Around	To directly communicate with other radios.



Note: Long and short press of a key can be a different functions by your dealer.

Before Use

Charging the Battery

Use only the charger and battery specified by Hytera. Charger LED can indicate the charging process.

■ Charge Diagram

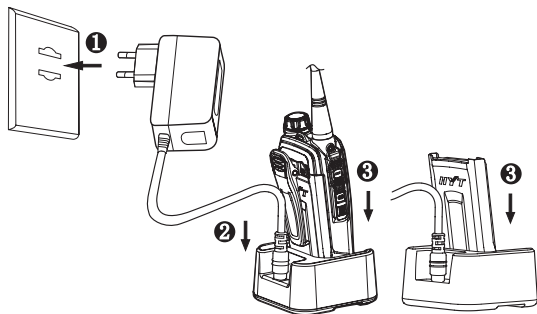

Procedures

1. Connect the power adapter to AC source. See arrow 1.
2. Plug the power adapter into the rear socket of the charger. See arrow 2.
3. Place the radio with the battery attached, or the battery alone, into the charger. See arrow 3.
4. The charging process initiates when LED glows red, and is completed when LED glows green.



Note: To achieve optimal battery performance, please charge the battery for 5 hours before initial use.

Charge Indicator

LED Indicator	Charge Status
LED solidly glows red.	Charging
LED solidly glows orange.	90% charged
LED solidly glows green.	Idle or charge completed

When battery power runs low, the LED will flash red, and the low-pitched tone will sound periodically. In this case, please replace or charge the battery.

Before Use



Note: Be sure to read the Safety Information Booklet, to get necessary safety information.

Assembly and Disassembly

■ Attaching the Antenna

Turn the antenna clockwise to fasten it.

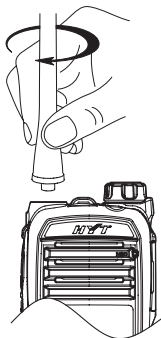

To remove the antenna, rotate it counter-clockwise.

■ Attaching the Battery

1. Press the belt clip and slide the battery into the radio's slot.
2. Slightly press the bottom of the battery until a click is heard.

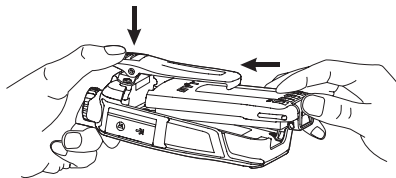

To remove the battery, turn off the radio first. Then press the belt clip, and slide the battery latch upward to release the battery.

Before Use

■ Attaching the Belt Clip

1. Remove the screws.
2. Align the screw holes on the belt clip with those on the radio's body, and then tighten the screws.

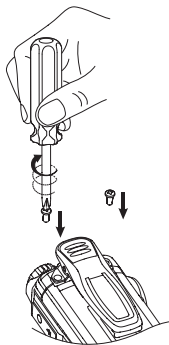

To remove the belt clip, loosen the screws.

■ Attaching Accessories

1. Open the accessory jack cover.

2. Plug an accessory into the accessory jack, and then tighten the screw.

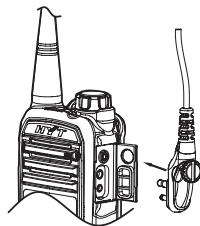













To remove accessories, loosen the screw first.













Caution: When you are using an external accessory, waterproof performance of the radio may get affected.

Status Indications

LCD Icons

Icon Name	Icon	Description
RSSI		There is no signal;
		There is signal for receiving;
Transmit Icon		Transmission is in progress;
Scan Icons		Scanning is in progress;
		Scanning pauses on a non-priority channel;
		Scanning pauses on Priority Channel 1;
Transmit Power Icons		The current channel is operating at low power;
		The current channel is operating at high power;
Battery Strength Icons	   	More bars indicate more battery power;

Home Channel Icon		The radio stays on a Home channel;
Monitor Icon		Monitor function is active;
Squelch Icon		Speaker is unmuted;
VOX Icon		VOX function is active;
Keypad Lock Icon		The keypad is locked;
Whisper Icon		Whisper function is active;
Scrambler Icon		Scrambler function is active;
Compandor Icon		Compandor function is active;
Emergency Icon		The Emergency function is active or an emergency alarm is received;
Talk Around Icon		Talk Around function is active;
CTCSS Icon	CT	TX/RX CTCSS is programmed on current channel;
CDCSS Icon	DT	TX/RX CDCSS is programmed on current channel;
DTMF Icon	DF	TX/RX DTMF is programmed on current channel.

Status Indications

LED Indicator

The top LED indicator will help you easily identify the current status of your radio.

LED Indicator	Radio Status
Red LED glows.	Transmitting
Red LED flashes.	Low battery alert
Green LED glows.	Receiving
Green LED flashes.	Scanning
Orange LED glows.	A call is transmitted (within the Auto Reset Time)
Orange LED flashes slowly.	A call is received (within the Auto Reset Time)
Orange LED flashes rapidly.	A call is missed

Basic Operations

Turning the Radio On/Off

Rotate the **Radio On-Off/Volume Control** knob clockwise/counter-clockwise until a click is heard to turn the radio on/off.

Entering Power-on Password

You may go to the menu “Settings->PowerOn PSW” to set the password on or off. See PowerOn PSW on page 18 for more details.

After you input the password, press  to confirm.

Then a power-on alert tone will sound, and the home screen will appear. However, if the password is incorrect, the display will show “Error”, prompting you to enter the password again.



Note:

- When PowerOn PSW is set on, you will be required to input the password to turn on the radio.
- The password is programmable by your dealer, and may contain up to 8 digits.

Adjusting the Volume

You may adjust call volume through the knob. Rotate the knob clockwise to increase the volume, or counter-clockwise to decrease the volume.



To adjust volume for alert tones or warning tones, go to the menu “Settings->Alert VOL / PowerOn VOL / Key VOL / Warning VOL” (See *Settings* on page 16 for more details).

Selecting a Zone

The radio supports up to 32 zones. You may choose to operate in a single zone, or choose Zone All so you

Basic Operations

can access all the available channels. You may select a zone through any of the following methods:



- You may quickly toggle to your desired zone, through press of the programmed **Zone Up** or **Zone Down** key; or
- Go to the menu “Zone”, press  /  to select your desired zone, and then press  to confirm.



Note: You may include channels in a zone in Manual Program mode, or ask your dealer to include them in a zone.

Selecting a Channel

The radio supports up to 256 channels. You may select a channel through any of the following methods:

- Press  /  to select your desired channel; or
- When the keypad input mode is set to Channel, directly enter the channel No., and then press





to switch to the channel (see *Keypad Mode Switch* on page 24 for more details); or

- Press the programmed **Home Channel** key to quickly switch to the Home channel (See *Home Channel* on page 23 for more details).

Inputting a Frequency

You can manually input a desired frequency within the frequency band of your radio, to transmit and receive calls. Operations:

1. Select Frequency from the menu “Keypad Mode”, and press .
 2. Return to the home screen, input your desired frequency through the keypad, and press .
- By way of illustration, to input frequency 365.65000MHz, just press the following keys one by one:

 +  +  +  +  +  + 

Basic Operations

Then the entered frequency will appear on the home screen, and you can transmit and receive on the frequency.





Note:

- The entered frequency will be saved if you turn the radio off and back on, but will not be saved if you change channel. It will be used for both transmitting and receiving. However, other channel parameters such as TX power and channel spacing will remain unchanged. To save the frequency permanently or to customize other channel parameters, enter the Manual Program mode and go to “CH Set” (See *CH Set* on page 31 for more details).
- If you enter a frequency out of the frequency band, the LCD will display “Out of Range”. If the entered frequency is not compliant with the rule, the radio will display a valid frequency closest to it.
- This function may not be available in certain countries or regions. Please contact your local dealer for more information.

Adjusting the Power Level

Generally, we recommend you to adopt low power for battery saving. However, if you cannot communicate with radios located at a distant place with low power, please select high power. Operations to change power level:

- Press the programmed **Adjust Power Level** key to switch between high and low; or
- Enter the Manual Program mode, and go to “CH Set->Option Items->Power Level”, to select high or low power (See *Power Level* on page 33 for more details).

The home screen shows the icon  for high power, and  for low power.

Transmitting/Receiving a Call

To transmit a call, press and hold down the **PTT**, and speak into the microphone. During transmitting, the LED solidly glows red, and the icon  appears on the display.

Basic Operations

To receive, just release the **PTT**. When a signal is received, the LED solidly glows green, and the icon  appears on the display.



Note:



- To ensure optimal volume of the receiving radio, hold the radio approximately 2.5 to 5 centimeters away from your mouth.
- Communication range may get affected in rainy days or forest locations.



Note: When the keypad is locked, the radio can also respond to the keys **PTT**, **SK1**, **SK2** and **TK**.



Locking/Unlocking the Keypad

Locking the keypad can prevent accidental keypad operation.

To lock or unlock the keypad, press  and then  immediately.

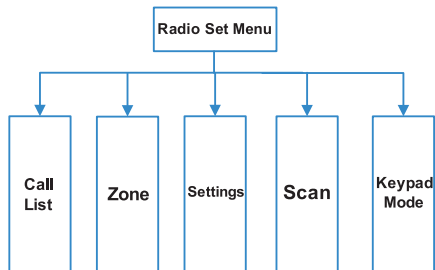
Menu Navigation



On the home screen, press  to access the main menu. Then press  /  to select a menu option from Call List, Zone, Settings, Scan, and Keypad Mode.

Call List

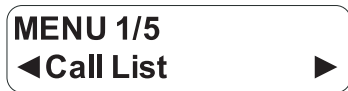

The radio supports up to 32 call lists. Under this menu, you may select a target contact, and then edit its alias or

ID, or press the **PTT** to transmit a call to the pre-defined user.

Zone

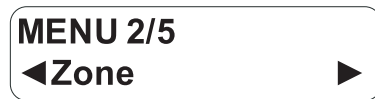

This menu allows you to select a zone.

Settings

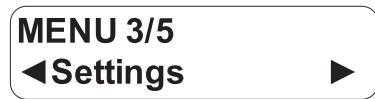

You can optimize your radio performance by customizing related parameters according to actual needs and your preferences.

This menu includes the following sub-menus:

Menu Navigation

■ VOX Gain

To select a VOX gain level.

Available options Off / Level 1 / Level 2 / Level 3 / Level 4 / Level 5



Note: Higher gain level represents higher sensitivity. If this option is set to Off, the VOX feature will not work even if it is enabled.

■ SQL

To select an appropriate squelch level.

Available options Open / Level 1 / Level 2 / Level 3 / Level 4 / Level 5 / Level 6 / Level 7 / Level 8 / Level 9



Note: Higher squelch level requires stronger signal for the radio to unmute. If this option is set to Open, the radio will keep unmuted irrespective of the satisfaction

■ Key Lock

The keypad will be locked automatically after the time set for the Key Lock option elapses.

Available options: Off / 5s / 10s / 15s / 30s / 60s



Note: If this option is set to Off, the keypad will not get locked automatically.

■ Backlight

To set the time duration that the backlight will keep lit.

Available options: Off / Infinite / 5s / 15s / 30s / 60s



Note: If this option is set to Off, the backlight will always remain disabled. If it is set to Infinite, the backlight will remain illuminated all the time.

■ Alert VOL

To set the volume level for alert tone (decoding alert).

Available options: Off / Level 1 / Level 2 / Level 3 / Level 4 / Level 5



Note: Higher level represents higher volume. If this option is set to Off, the radio will not sound decoding alert tone.

■ PowerOn VOL

To set the volume level for power-on alert tone.

Available options: Off / Level 1 / Level 2 / Level 3 / Level 4 / Level 5



Note: Higher level represents higher volume. If this option is set to Off, the radio will not sound power-on alert tone.

■ Key VOL

To set the volume level for key press alert such as front panel key press alert, error alert, TX inhibit alert and cycle alert.

Available options: Off / Level 1 / Level 2 / Level 3 / Level 4 / Level 5



Note: Higher level represents higher volume. If this option is set to Off, the radio will not sound the above key-press alert tones.

■ Warning VOL

To set the volume level for warning tones such as function on/off alert, TOT alert, low battery alert and priority channel alert.

Available options: Off / Level 1 / Level 2 / Level 3 / Level 4 / Level 5



Note: Higher level represents higher volume. If this option is set to Off, the radio will not sound warning alert tone.

■ PowerOn PSW

To set whether power-on password is required for you to turn the radio on.

Available options: On/ Off

Menu Navigation



Note: If no power-on password is set by your dealer, this menu option will be invalid.

■ CH Display

To select the channel information to be displayed on the home screen.

Available options: Number/ Frequency/ Alias

■ Radio Info

To view some radio information.

Available information: Firmware Ver / SN

Scan

MENU 4/5

◀ **Scan** ▶

To set Scan on or off.

Keypad Mode

MENU 5/5

◀ **Keypad Mode** ▶

To select keypad entry mode.

Available options are:

Disabled: To disallow entry through the keypad.

Channel: You can input channel number through the keypad.

DTMF: You can input DTMF code through the keypad.

Frequency: You can input frequency through the keypad.



Note: This function may not be available in certain countries or regions. Please contact your local dealer for more information.

Functions and Operations

Time-out Timer (TOT)

The purpose of TOT is to prevent any user from occupying a channel for an extended period. When the preset time expires, the radio will automatically terminate transmission and keep beeping. To stop beeping, please release the **PTT** key. You must wait for a certain time period (preset by your dealer) to initiate another transmission.

If the Pre-alert function is activated by your dealer, your radio will alert you to the TOT expiration in advance.





Note: This feature is null in Emergency mode.

Channel Scan



This feature allows you to listen to communication activities on other channels so that you can keep a close track of your team members.



The scan list can be set by your dealer, and a maximum of 32 channels are allowed for each scan list.

Operation:

1. To activate this function, press the programmed Scan key; or select “On?” from the menu “Scan”, press  to confirm; or switch to a channel with Auto Scan feature enabled (programmed by your dealer).
2. After scan is enabled, the radio will sound an alert tone (programmed by your dealer), and begin to scan the programmed scan list. The scanning process is as follows:
 - During scanning, LCD displays icon , and LED flashes green.
 - When communication activities are detected on a channel, or the programmed **Monitor** key is pressed, or the **PTT** is pressed to transmit, the radio will stay to receive activities present on this channel. If your radio stays on a non-priority

Functions and Operations

channel, the LCD will display ; if it stays on Priority Channel 1, the LCD will display .

- If the Talk Back feature is enabled by your dealer, press the **PTT** to reply when the radio stays on a certain channel.
 - You can scan the frequently used Priority Channel (only one Priority Channel allowed). When staying on a non-priority channel, the radio will keep detecting activities on the priority channel. Once any activity is detected, it will jump to the priority channel immediately. For more information, please contact your dealer.
3. To exit the scanning process, press the Scan key again; or select “Off?” from the menu “Scan”, and press  to confirm. When exiting from Scan mode, the radio will also sound an alert tone (programmed by your dealer) and the icon  disappears.

Methods to Exit Scanning

Besides the above methods, you can exit scanning in the following ways:

- Switch to a channel where Auto Scan feature is not enabled;
- Press one of the programmed **Call1-Call5** keys;
- Select a target contact from the menu “Call List”, and press **PTT**;
- Enable the Emergency function;
- Turn the radio off.



Note:

- During scanning, the following functions can not be enabled: Power Adjust, Com-pandor, Scrambler, Whisper, Talk Around and Keypad Mode Switch.
- To ensure a quick scan, the adjacent channel spacing should not exceed 30MHz.

Functions and Operations

Emergency

In case of an emergency, you can use this feature to ask for help from your companion or the control center.

■ Emergency Start

Press the programmed **Emergency** key to trigger this function (the icon  appears).

■ Emergency Exit

The radio will return to the previous operating channel after exiting from Emergency mode (the icon disappears).

Ways to exit from Emergency mode include:

1. Long press the programmed **Emergency** key; or
2. The emergency cycles (programmed by your dealer) expires; or
3. Turn the radio off.

■ Emergency Mode

Once the radio enters Emergency mode, it will switch

to the preset Emergency Revert Channel. A complete process includes four stages: 1) Transmit the ID; 2) Transmit the alarm; 3) Transmit the background tone; and 4) Forcibly receive. The cycles and duration of each stage can be programmed by your dealer. Please ask your dealer to program one of the following Emergency modes:

1. No alarm tone sounds;
2. The alarm tone can be heard by the transmitting party only;
3. The alarm tone can be heard by the receiving party only ;
4. The alarm tone can be heard by both parties.

Quick Call

This feature allows you to call other radios quickly.

Operation:

- Press the programmed **Call1-Call5** key, which is assigned with a unique radio ID respectively; or

Functions and Operations

- Select the target ID through the menu “Call List”, and press **PTT**.



Note: Please request your dealer to assign your desired radio IDs to **Call1-Call5** respectively.



Note: If the Auto Reset Timer is enabled by your dealer, the radio will automatically switch to the Home channel when the timer expires and there is no operation (like key-press, transmitting or receiving operations)

Home Channel

This feature allows you to switch to the Home channel, namely, the most frequently used channel. It can be programmed by your dealer. This radio supports one Home channel only.

Operation:

Press the programmed **Home Channel** key to switch to the predefined Home channel ( appears on the LCD). To return to the previous non-home channel, press this key again (the icon disappears).

Display Mode Switch

This feature allows you to select the channel information to be displayed on the home screen. The following three options are available: Number, Alias and Frequency. For example, if you choose Number, the home screen will display the number of your current channel.

Operation:

- Press the programmed **Display Mode Switch** key to switch the mode; or
- Select your desired display mode through “CH Display” under the menu “Settings”, and press  to confirm.

Keypad Mode Switch

This feature allows you to choose one of these keypad input modes: Disabled, Frequency, Channel and DTMF.

Operation:

- Press the programmed **Keypad Mode** key to switch the keypad input mode; or
- Select your desired keypad input mode through the menu “Keypad Mode”, and press  to confirm.



Note: This function may not be available in certain countries or regions. Please contact your local dealer for more information.

Talk Around

This feature allows you to continue communication even when the repeater malfunctions, or when your terminal is out of the repeater’s range but within the coverage range of another terminal.



Operation:

Press the programmed **Talk Around** key to activate this function ( appears and an alert tone sounds). To deactivate this function, just press it again, or switch to another channel, or power the radio off (the icon disappears and the alert tone sounds twice).

Monitor

This feature allows you to lower the conditions for incoming signal match.

Operation:

- Press the programmed **Monitor** key to activate this function ( appears and an alert tone sounds); press it again to deactivate the function (the icon disappears and the alert tone sounds twice). Or
- Press and hold the programmed **Monitor Momentary** key to activate this function ( appears and an alert tone sounds); release the

Functions and Operations

key to exit (the icon disappears and the alert tone sounds twice).





Note: In Auto Reset mode, press the programmed Monitor or Monitor Momentary key to cancel a call.

Squelch Off

This feature allows you to unmute the speaker to receive all audio signals on current channel.

Operation:

- Press the programmed **Squelch Off** key to activate this function ( appears and an alert tone sounds); press the key again to deactivate it (the icon disappears and the alert tone sounds twice).
Or
- Press and hold the programmed **Squelch Off Momentary** key to activate this function ( appears and an alert tone sounds); release the key to deactivate it (the icon disappears and the alert tone sounds twice).



Note:

- In Auto Reset mode, pressing the programmed **Squelch Off** or **Squelch Off Momentary** key would cancel a call.
- When this function is enabled on current channel, you will hear audio signals (if any); otherwise, background noise will be heard.

Compandor

This feature may suppress ambient noise and improve audio quality, allowing you to hear clear and crisp voice even in noisy environment.

Operation:

Press the programmed **Compandor** key to activate this function ( appears and an alert tone sounds); press the key again to deactivate it (the icon disappears and the alert tone sounds twice). Or

Functions and Operations



Note: This function can be enabled or disabled on a designated channel by your dealer.

Scrambler

This feature can encrypt your audio signals to prevent eavesdropping. Thus privacy of your voice communication is guaranteed.

Operation:

- Press the programmed **Scrambler** key to activate this function ( appears and an alert tone sounds); press the key again to deactivate it (the icon disappears and the alert tone sounds twice).
Or
- Switch to a channel programmed with this feature by your dealer; exiting from this channel would deactivate the function.



Note: This function may vary with different radio models.

This function may not be available in certain countries or regions. Please contact your local dealer for more information.

VOX

This feature allows you to transmit the voice with no need to press **PTT**. However, you must employ a dedicated earpiece to realize this function.

Operation:

1. Set the **PTT/VOX Switch** on the earpiece to **VOX**;
2. Plug the earpiece into the accessory jack;
3. Press the programmed **VOX** key to activate this function ( appears on the LCD);
4. Speak into the microphone (on the earpiece) to transmit your voice, and transmission will stop automatically when you stop talking;

Functions and Operations

5. Power the radio off or press the **VOX** key again to deactivate this function.



Note:

- If the **PTT/VOX Switch** on the earpiece is set to PTT, you can only transmit by pressing the external **PTT**, no matter whether VOX is activated.
- When the **PTT/VOX Switch** is set to PTT, you are not allowed to switch it from PTT to VOX directly; otherwise, continuous transmission may occur. If continuous transmission occurs unexpectedly, you can restore the radio to normal operation by toggling the switch from VOX to PTT, or turning the radio off and back on.
- You can select an appropriate VOX sensitivity according to the environment. If there are heavy noises, you'd better select a lower VOX sensitivity.

Whisper

With this feature, even if you speak with a very low voice, it can still be heard clearly by the receiving party.

Operation:

Press the programmed **Whisper** key to activate this function ( appears and an alert tone sounds); press the key again to deactivate it (the icon disappears and the alert tone sounds twice).

Reverse Display

With this feature, the displayed information on the display can be rotated by 180 degrees.

Operation:

Press the programmed **Reverse Display** key to rotate the displayed information by 180 degrees (an alert tone sounds); press this key again to restore the display (an alert tone sounds twice).

Signaling Introduction

CTCSS/CDCSS and DTMF signalings are available with TC-580. For detailed information, please contact your dealer.

CTCSS/CDCSS

CDCSS/CTCSS can be used to prevent unwanted conversations at the same frequency. If CTCSS/CDCSS is set on a certain channel, you can only receive voice calls from radios with matching CTCSS/CDCSS. Otherwise you will receive voice calls from all users operating at the same frequency.

You may request your dealer to program corresponding parameters; alternately, you can program them manually through your radio by yourself. For more information, please refer to the section “RX CTC/CDC” and “TX CTC/CDC” in Manual Program on page 32.

Dual Tone Multiple Frequency (DTMF)

Methods to transmit DTMF signaling:

1. Enter the menu Call List, select your desired contact

entry, and press **PTT** to transmit; or

2. Press the programmed **Call1-Call5** key to transmit; or



Note: To enable this feature, DTMF signaling must be enabled on current channel via

3. Enter the DTMF code on the home screen, and then press **PTT** to transmit.



Note: The DTMF code is comprised of 0-9, A-D, * and #.

During transmission, the LED glows red solidly; after transmission, it solidly glows orange within the auto reset time (programmed by your dealer).

Decoding DTMF signaling:

When a channel is programmed to receive DTMF signaling, the radio will decode matching DTMF signaling only.

When the radio is receiving DTMF signaling, the LED glows green solidly; after it successfully receives

Signaling Introduction

the signaling, the LED keeps flashing orange for a predefined time period.

- **When an Emergency alarm is received**

The radio will sound a fixed Emergency alert tone when it receives an Emergency Alarm (an Emergency ID should be programmed at first).

- **When an individual call is received**

The radio will sound a personalized alert tone when it receives an Individual Call (an Individual Call ID should be programmed at first).

- **When a group call is received**

The radio will sound a personalized alert tone when it receives a Group Call (a Group Call ID should be programmed at first).

- **When calls of other types are received**

If the radio is programmed to display IDs, such IDs will be displayed on the LCD when calls of other types are received.

- **Types of Response**

Your radio may be set to give any of the following

types of response, when it receives an individual call or group call:

- 1) The radio gives no response.
 - 2) **Silent Alert:** The LCD will display “Alert Call Received”, but no sound alert will be given.
 - 3) **Sound Alert:** The LCD will display “Alert Call Received” with sound alert, and only the sound alert will automatically reset.
 - 4) **Select Call Alert:** The LCD will display “Select Call Received” with sound alert. Both the sound alert and displayed text will automatically reset.
- **ACK (Acknowledge):** If the ACK feature is enabled, the radio will send back a single tone or its PTT ID to the calling party when it receives an individual call or group call.



Note: Please request your dealer to program the individual call ID, group call ID and emergency call ID, as well as response method, ID display feature and ACK feature of DTMF decoding.

Manual Program

The radio supports convenient programming of zone and channel related parameters from the front panel.

However, this function may not be available in certain countries or regions. Please contact your local dealer for more information.

To enter the Manual Program mode:

Rotate the **Radio On-Off/Volume Control** knob, with both **PTT** and **SK2** held down for above 1.5 seconds, to turn the radio on. Then the radio will enter the Manual Program mode. When “Manual Program” appears on the LCD, press  to begin settings of parameters.

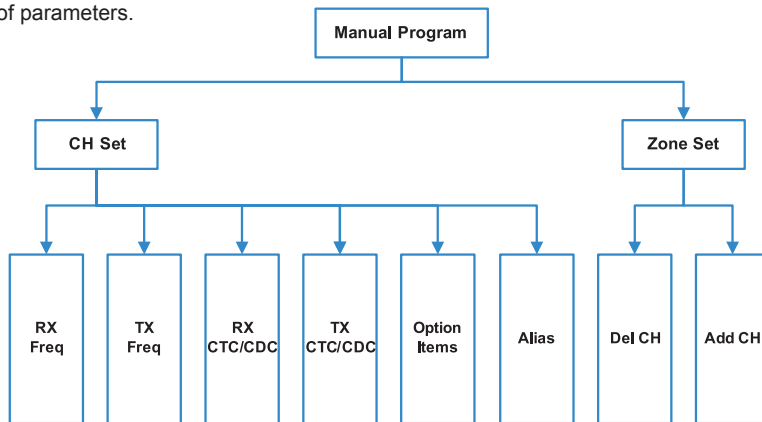





Manual Program

CH Set



Manual PROG 1/2
◀ CH Set ▶

The CH Set menu allows you to add or delete channels, and set channel parameters and features.

Operations:

Select CH Set and press . Then press  /  to select a channel one by one, or press  /  to scroll by page (each page includes ten channels). The radio supports up to 256 channels. Under the CH Set menu, specific channel No. will be displayed for existing channels, while "CH --" will be displayed for non-existing channels. Available operations:

Delete a channel: select an existing channel, and press . Then the LCD will give a prompt "Del CH?".



You may press  to delete this channel, or press  to cancel.



Note: After you delete a channel,





- You cannot select the deleted channel for use.
- If the deleted channel is the designated Power-on channel or Home channel, the designation will become invalid automatically.
- If the deleted channel is a designated Revert Channel, signaling transmission on the channel will fail.
- If the deleted channel is a member included in the scan list, it will be ignored during scanning. If all channels in the scan list are deleted, you will be unable to activate scanning.
- If all channels in a zone are deleted, the radio will alert you of an empty zone and sound warning tone.

Manual Program

Add a channel: select “CH --” -> press  -> select “RX Freq” -> press  -> enter the RX frequency (see *Inputting a Frequency* on page 13 for the method to input a frequency) -> press . Then the channel will be added successfully.



Note: You must enter a valid RX frequency to add a channel.

Edit parameters: select an existing channel -> press  -> press  /  to select the option to set -> press  to set. Available parameters are:

■ RX Freq

To set the RX frequency for the current channel.
Operations:

1. Press , and then enter the RX frequency.

2. Press  to save it.

■ TX Freq



To set the TX frequency for the current channel.
Operations:

1. Press , and then enter the TX frequency.

2. Press  to save it.

■ RX CTC/CDC

You can set RX CTCSS/CDCSS signaling to CTC/CDC None, CTC, Normal CDC, or Invert CDC, and you can also customize the signaling. Operations:

1. Select RX CTC/CDC -> press  -> press 

/  to select the desired signaling type -> press

 to customize the signaling.

2. Press  to save the signaling.

■ TX CTC/CDC

You can set TX CTCSS/CDCSS signaling to CTC/CDC None, CTC, Normal CDC, or Invert CDC, and you can also customize the signaling. Operations are the same as that in “RX CTC/CDC”.



Note: If CTCSS/CDCSS signaling exceeds the following range, your radio performance will not be guaranteed.

Recommended range for CTCSS:
67Hz~254.1Hz

Recommended range for CDCSS:
023~754

Option Items

You can customize channel related parameters according to actual needs and your preferences. Available parameters are:

CH Spacing

To set channel spacing to wide or narrow.

Available options: Wide/ Narrow

Power Level

To set TX power level.

Available options: Low/ High

Whisper

To enable or disable the Whisper feature.

Available options: Disabled/ Enabled

Compandor

To enable or disable the Compandor feature.

Available options: Disabled/ Enabled

Scrambler



To enable or disable the Scrambler feature.

Available options: Disabled/ Enabled

Manual Program

Alias

To set the alias for the current channel. Operations:





1. Press  and then enter the alias (up to 10 characters).
2. Press  to save the alias.

Zone Set





Manual PROG 2/2
◀ Zone Set ▶

This menu allows you to add or delete zones and channels.

Operations:

Select Zone Set and press . Then press  /  to select a zone one by one, or press  /  to scroll by page (each page includes ten zones). The radio supports up to 32 zones. Under the Zone Set menu, specific

zone No. will be displayed for existing zones, while “Zone --” will be displayed for non-existing zones. Available operations:

Delete a zone: you can delete an existing zone by deleting all channels included in it. The deleted zone will be displayed as “Zone - -”. Select an existing zone -> press  -> press  to select “Del CH” -> press  -> press  repeatedly to delete all channels in the current zone.





Note: You cannot select an empty zone in User Mode.

Add a zone: You can add a zone by adding one or more channels into it. Select “Zone --” -> press  -> press  (when “Add CH” appears) -> press  /  to select a channel



Manual Program

and then press  to add it. You may repeat the last step to add more channels.

Edit a zone: select an existing zone -> press  -> press  /  to select "Add CH" or "Del CH".

Add CH

You may add channels to the current zone. Operations:



1. Press  /  to select a channel to add.
2. Press  to add it (LCD will display the next available channel).



Note: If the currently selected channel is already included in the zone, the LCD will give you a prompt.

Del CH

You may delete channels from the current zone. Operations:

1. Press  /  to select a channel to delete.
2. Press  to delete it (LCD will display the next available channel).

Troubleshooting

Phenomena	Analysis	Solution
The radio can not be powered on.	The battery may be improperly installed.	Remove the battery and attach it again.
	The battery may have run out.	Recharge or replace the battery.
	The battery may suffer from poor contact caused by dirtied or damaged battery contacts.	Clean the battery contacts. If the problem can not be solved, contact your dealer or our authorized service center for inspection and repair.
During receiving signals, the voice is weak, discontinuous or totally inactive.	The battery strength may be too low.	Recharge or replace the battery.
	The volume may be set to a low level.	Increase the volume.
	The antenna may get loose or may be improperly installed.	Power off the radio, re-install the antenna and power on the radio again.
	The speaker may be blocked or damaged.	Clean surface of the speaker. If the problem can not be solved, contact your dealer or our authorized service center for inspection and repair.

Troubleshooting

You can not communicate with other members.	The frequency or signaling may be inconsistent with that of other members.	Set your frequency and signaling to the same as that of other members.
	You may be too far away from the group members.	Move towards other members. And make sure that you are within the communication range.
Irrelevant communication activities or noises are heard on the channel.	You may be interrupted by radios using the same frequency.	Change the frequency, or adjust the squelch level.
	The radio may be set with no signaling.	Set signaling for all member radios to avoid interference at the same frequency.
The noise is too loud.	You may be too far away from other members.	Move towards other members, power off your radio and then restart it.
	You may be at an unfavorable position. For example, your communication may be blocked by high buildings or frustrated in the underground areas.	Move to an open and flat area, and restart the radio.
	You may suffer from external disturbance (such as electromagnetic interference).	Stay away from equipment that may cause interference.

If the above solutions can not fix your problems, or you may have some other queries, please contact us or your local dealer for more technical support.

Care and Cleaning

To guarantee optimal performance as well as a long service life of your radio, please follow the tips below.

Radio Care

- Keep the radio far away from substances that can corrode the circuit.
- Do not hold the radio by its antenna or earpiece cable directly.
- Attach the accessory jack cover when the radio is not in use.

Radio Cleaning

- Clean up the dust and fine particles on the radio surface and charging piece with a clean and dry lint-free cloth or a brush regularly.
- Use neutral cleanser and a non-woven cloth to clean the keys, control knobs and front case regularly. Do not use chemical preparations such as

stain removers, alcohol, sprays or oil preparations, so as to avoid surface case damage. Make sure the terminal is completely dry before use.



Caution: Power off the radio and remove the battery before cleaning.

Optional Accessories

The following items are the main optional accessories for the radio, and please consult your local dealer for more accessories.



Li-Ion Battery (1100mAh)

BL1102

Li-Ion Battery (1300mAh)

BL1301



Vehicle Adapter for
Charger CHV09



Six-unit Switching
Power PS7002 (The
power cable may vary
in different countries
and areas)



Earbud with in-Line
PTT & VOX ESM11



Earbud with on-MIC
PTT & VOX ESM12



D-earset with Boom
MIC & VOX EHM16



D-earset with in-Line
MIC & VOX EHM15



Earpiece with on-MIC
PTT & VOX & Trans-
parent Acoustic Tube
EAM12

Optional Accessories



Remote Speaker Microphone SM08M3



Receive-Only Earpiece with Transparent Acoustic Tube (for use with remote speaker microphone) ESS08



Receive-Only Earbud (for use with remote speaker microphone) ESS07













Note: Use only the accessories specified by Hytera only. If not, Hytera shall not be liable for any losses or damages arising out of use of other unauthorized accessories.

Appendix: Input Method

You can enter channel number, alias, frequency or DTMF code using the keypad. This radio supports the following input methods: Number (“123”) and English (“ABC”/“abc”).

Use the following keys as instructed:

Key	Function
 / 	To move the cursor.
	To confirm your entry.
	To delete the characters.
	In English input method, press this key repeatedly to enter “#”, “1” and punctuations in order; In Number input method, press this key to enter “1”.
 - 	To enter the number or letter born on the key.

	In English input method, press this key to enter a space, and double press it to enter “0”; In Number input method, press this key to enter “0”.
	In English input method, press this key to enter “*”, and double press it to enter “.”; In Number input method, press this key to enter “*”.
	To switch the input method.

English Input Method

The 26 letters are distributed among the alphanumeric keys 2~9. Press the key which bears your desired letter repeatedly until the letter appears. If the next letter

Appendix: Input Method

is also located on the present key, wait until the cursor moves to the next entry position, and then input the letter. For example, to input the word “come”:

1. Press **2 ABC** repeatedly until “c” appears;
2. Press **6 MNO** repeatedly until “o” appears;
3. Wait until the cursor moves to the next entry position, press **6 MNO** again repeatedly until “m” appears;
4. Press **3 DEF** repeatedly until “e” appears.

Number Input Method

When the input method is switched to Number, press appropriate key to enter your desired number. For example, to input the number “130”, you just need to press **1|<** , **3 DEF** and **0 END** orderly.